

# OWNER'S GUIDE

---

READ AND SAVE THESE INSTRUCTIONS

---

**TAPPAN**  
*Millennia*



<i>Product Registration</i> .....	2
<i>Versión en español</i> .....	2
<i>Version française</i> .....	2
<b>IMPORTANT SAFETY INSTRUCTIONS</b> .....	3-4
<i>Grounding Instructions</i> .....	4
<i>Setting the Clock and Minute Timer</i> .....	5
<i>Flame Size</i> .....	6
<i>Proper Burner Adjustments</i> .....	6
<i>Setting Surface Controls</i> .....	6
<i>Before Setting Oven Controls</i> .....	7
<i>Setting Oven Controls</i> .....	8
<i>Oven Cleaning</i> .....	9-10
<i>General Cleaning</i> .....	11-13
<i>Changing Oven Light</i> .....	13
<i>Avoid Service Checklist</i> .....	14-15
<b>TAPPAN RANGE WARRANTY</b> .....	16

## **GAS RANGE**

SEALED SURFACE BURNERS WITH  
PORCELAIN ENAMEL OR  
CONTINUOUS CLEANING OVEN

# Product Registration

## Register Your Product

The self-addressed **PRODUCT REGISTRATION CARD** should be filled in completely, signed and returned to Frigidaire Home Products.

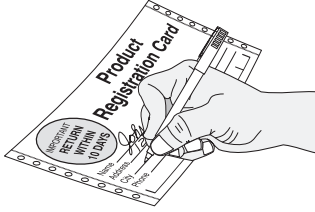

## Versión en español

Si desea obtener una copia en español de este Manual del Usuario, sírvase escribir a la dirección que se incluye a continuación.

Solicite la P/N316000189S.

## Version française

Si vous désirez obtenir un exemplaire de la version française de ce "Guide de l'utilisateur," faites-en la demande par écrit à l'adresse indiquée ci-dessous. Exigez qu'on vous livre le N° de pièce 316000189F.

French Owner's Guides **-OR-**  
Spanish Owner's Guides (please specify)  
Frigidaire Company  
P. O. Box 9061  
Dublin, Ohio 43017-0961

Thank you for choosing this appliance. The information contained within this **Owner's Guide** will instruct you on how to properly operate and care for your range. Please read through the information contained in your literature pack to learn more about your new appliance.

## Record Your Model and Serial Numbers

Record in the space provided below the model and serial numbers found on the right side of the oven front frame in the storage compartment or on the oven floor shield.

Model Number: \_\_\_\_\_

Serial Number: \_\_\_\_\_

Date of Purchase: \_\_\_\_\_

This Owner's Guide contains general operating instructions for your range and feature information for several models. Your range **may not** have all the described features.

**Note:** The instructions appearing in this Owner's Guide are not meant to cover every possible condition and situation that may occur. Common sense and caution must be practiced when installing, operating and maintaining any appliance.



**⚠ WARNING** If the information in this manual is not followed exactly, a fire or explosion may result causing property damage, personal injury or death.

### FOR YOUR SAFETY:

- Do not store or use gasoline or other flammable vapors and liquids in the vicinity of this or any other appliance.
- **WHAT TO DO IF YOU SMELL GAS:**
  - Do not try to light any appliance.
  - Do not touch any electrical switch; do not use any phone in your building.
  - Immediately call your gas supplier from a neighbor's phone. Follow the gas supplier's instructions.
  - If you cannot reach your gas supplier, call the fire department.
- Installation and service must be performed by a qualified installer, servicer or the gas supplier.

# IMPORTANT SAFETY INSTRUCTIONS

Read all instructions before using this appliance.

Save these instructions for future reference.

This guide contains important safety symbols and instructions. Please pay attention to these symbols and follow all instructions given. Here is a brief explanation of the use of these symbols.

**⚠ WARNING** This symbol will help alert you to situations that may cause serious bodily harm, death or property damage.

**⚠ CAUTION** This symbol will help alert you to situations that may cause bodily injury or property damage.

- **Remove all tape and packaging before using the range.** Destroy the carton and plastic bags after unpacking the range. Never allow children to play with packaging material.
- **Proper Installation—Be sure your appliance is properly installed and grounded by a qualified technician in accordance with the National Fuel Gas Code ANSI Z223.—latest edition, or in Canada CAN/CGA B149.1, and CAN/CGA B149.2, and the National Electrical Code ANSI/NFPA No. 70—latest edition, or in Canada CSA Standard C22.1, Canadian Electrical Code Part 1, and local code requirements.** Install only per installation instructions provided in the literature package for this range. Ask your dealer to recommend a qualified technician and an authorized repair service. Know how to disconnect the power to the range at the circuit breaker or fuse box in case of an emergency.
- **User servicing—Do not repair or replace any part of the appliance unless specifically recommended in the manuals.** All other servicing should be done only by a qualified technician. This may reduce the risk of personal injury and damage to the range.
- **Never modify or alter the construction of a range by removing leveling legs, panels, wire covers, anti-tip brackets/screws, or any other part of the product.**

## ⚠ WARNING

- All ranges can tip.
- Injury to persons could result.
- Install anti-tip device packed with range.
- See Installation Instructions.



**⚠ WARNING** To reduce the risk of tipping, the range must be secured by properly installed anti-tip bracket provide with the range. To check if the bracket is installed properly, visually check that rear leveling leg is inserted into and fully secured by the anti-tip bracket by removing lower panel or storage drawer. For models with a warmer drawer or broiler drawer, grasp the top rear edge of the range and carefully attempt to tilt it forward. Refer to the Installation Instructions for proper anti-tip bracket installation.



**⚠ WARNING** Stepping, leaning or sitting on the doors or drawers of this range can result in serious injuries and also cause damage to the range. Do not allow children to climb or play around the range. The weight of a child on an open door may cause the range to tip, resulting in serious burns or other injury.

**⚠ WARNING** Do not use the oven, broiler compartment or warmer drawer for storage.

**⚠ CAUTION** Do not store items of interest to children in the cabinets above a range or on the backguard of a range. Children climbing on the range to reach items could be seriously injured.

**⚠ WARNING** Never Use Your Appliance for Warming or Heating the Room.

- **Storage in or on Appliance—Flammable materials should not be stored in an oven, warmer drawer, broiler compartment, near surface burners, broiler compartment or in the storage drawer.** This includes paper, plastic and cloth items, such as cookbooks, plasticware and towels, as well as flammable liquids. Do not store explosives, such as aerosol cans, on or near the range.
- **Do Not Leave Children Alone—Children should not be left alone or unattended in the area where appliance is in use.** They should never be allowed to sit or stand on any part of the appliance.
- **DO NOT TOUCH SURFACE BURNERS, AREAS NEAR THESE BURNERS, OVEN BURNERS OR INTERIOR SURFACES OF THE OVEN.** Both surface and oven burners may be hot even though flames are not visible. Areas near surface burners may become hot enough to cause burns. During and after use, do not touch, or let clothing or other flammable materials touch these areas until they have had sufficient time to cool. Among these areas are the cooktop, surfaces facing the cooktop, the oven vent openings and surfaces near these openings, oven door and window.
- **Wear Proper Apparel—Loose-fitting or hanging garments should never be worn while using the appliance.** Do not let clothing or other flammable materials contact hot surfaces.
- **Do Not Use Water or Flour on Grease Fires—Smother the fire with a pan lid, or use baking soda, a dry chemical or foam-type extinguisher.**
- **When heating fat or grease, watch it closely.** Fat or grease may catch fire if allowed to become too hot.
- **Use Only Dry Potholders—Moist or damp potholders on hot surfaces may result in burns from steam.** Do not let potholders touch hot heating elements. Do not use a towel or other bulky cloth instead of a potholder.
- **Do Not Heat Unopened Food Containers—Buildup of pressure may cause container to burst and result in injury.**
- **Remove the oven door from any unused range if it is to be stored or discarded.**

**IMPORTANT—ELECTRIC IGNITION MODELS ONLY:** Do not attempt to operate the oven during a power failure. If the power fails, always turn off the oven. If the oven is not turned off and the power resumes, the oven will begin to operate again. Once the power resumes, reset the clock and oven function.

# IMPORTANT SAFETY INSTRUCTIONS

## IMPORTANT INSTRUCTIONS FOR USING YOUR COOKTOP

**⚠️ WARNING** Use Proper Flame Size—Adjust flame size so it does not extend beyond the edge of the utensil. The use of undersized utensils will expose a portion of the burner flame to direct contact and may result in ignition of clothing. Proper relationship of utensil to flame will also improve efficiency.

- **Know which knob controls each surface burner.** Place a pan of food on the burner before turning it on, and turn the burner off before removing the pan.
- **Always turn knob to the full LITE position when igniting top burners.** Visually check that burner has lit. Then adjust the flame so it does not extend beyond the edge of the utensil.
- **Utensil Handles Should Be Turned Inward and Not Extend Over Adjacent Surface Burners**—To reduce the risk of burns, ignition of flammable materials, and spillage due to unintentional contact with the utensil, the handle of the utensil should be positioned so that it is turned inward, and does not extend over adjacent surface burners.
- **Never Leave Surface Burners Unattended at High Heat Settings**—Boilovers cause smoking and greasy spillovers that may ignite, or a pan that has boiled dry may melt.
- **Protective Liners**—Do not use aluminum foil to line surface burner pans, or oven bottom, except as suggested in this manual. Improper installation of these liners may result in risk of electric shock, or fire.
- **Glazed Cooking Utensils**—Only certain types of glass, glass/ceramic, ceramic, earthenware, or other glazed utensils are suitable for cooktop service without breaking due to the sudden change in temperature. Check the manufacturer's recommendations for cooktop use.

## SAVE THESE INSTRUCTIONS

## IMPORTANT INSTRUCTIONS FOR USING YOUR OVEN

- **Use Care When Opening Oven Door or Warmer Drawer**—Stand to the side of the range when opening the door of a hot oven. Let hot air or steam escape before you remove or replace food in the oven.
- **Keep Oven Vent Ducts Unobstructed.** The oven vent is located below the backguard. Touching the surfaces in this area when the oven is operating may cause severe burns. Also, do not place plastic or heat-sensitive items on or near the oven vent. These items could melt or ignite.
- **Placement of Oven Racks.** Always place oven racks in desired location while oven is cool. If rack must be moved while oven is hot use extreme caution. Use potholders and grasp the rack with both hands to reposition. Do not let potholders contact the hot heating elements in the oven. Remove all utensils from the rack before moving.
- **Do not use the broiler pan without its insert.** The broiler pan and its insert allow dripping fat to drain and be kept away from the high heat of the broiler.
- **Do not cover the broiler insert with aluminum foil.** Exposed fat and grease could ignite.

## IMPORTANT INSTRUCTIONS FOR CLEANING YOUR RANGE

- **Clean the range regularly to keep all parts free of grease that could catch fire.** Pay particular attention to the area underneath each surface element. Do not allow grease to accumulate. Refer to the hood manufacturer's instructions for cleaning.
- **Kitchen cleaners and aerosols**—Always follow the manufacturer's recommended directions for use. Be aware that excess residue from cleaners and aerosols may ignite causing damage and injury.

## CONTINUOUS CLEANING OVENS

- **Do Not Use Oven Cleaners on the oven liner or any of the continuous cleaning surfaces.** Continuous cleaning surfaces can be identified by their rough surface finish.

## Grounding Instructions

(electric ignition models only)

**⚠️ WARNING** Avoid fire hazard or electrical shock. Do not use an adapter plug, an extension cord, or remove grounding prong from electrical power cord. Failure to follow this warning can cause serious injury, fire or death.

**⚠️ WARNING** This appliance is equipped with a 3-prong grounding plug for your protection against shock hazard and should be plugged directly into a properly grounded receptacle. **DO NOT** cut or remove the grounding prong from this plug.

For personal safety, the range must be properly grounded. For maximum safety, the power cord must be plugged into an electrical outlet that is correctly polarized and properly grounded.

**DO NOT** Operate the range using a 2-prong adapter or an extension cord. If a 2-prong wall receptacle is the only available outlet, it is the personal responsibility of the consumer to have it replaced with a properly grounded 3-prong wall receptacle installed by a qualified electrician.

See the **INSTALLATION INSTRUCTIONS** packaged with this range for complete installation and grounding instructions.

Grounding type wall receptacle

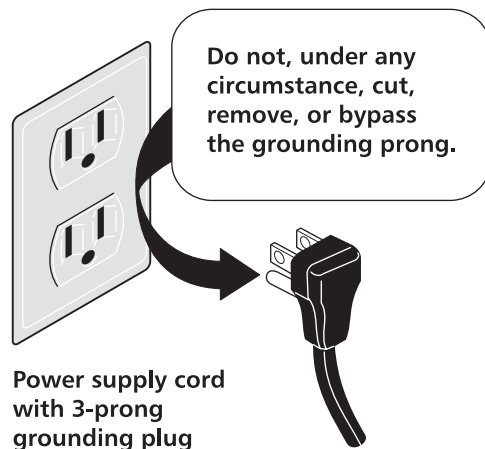

## Setting the Clock and Minute Timer

(some models)

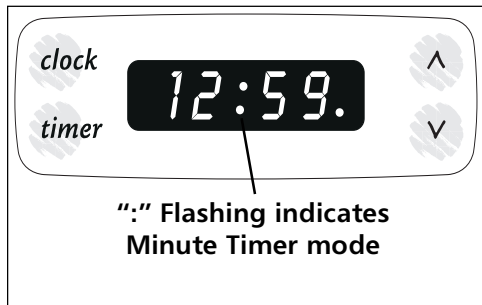

Your model may be equipped with the clock shown below. Follow the instructions to set the clock and minute timer on your range.

### To Set the Clock

When the range is first plugged in, or when the power supply to the range has been interrupted, "12:00" will flash in the display window.

1. Push *clock*.
2. Push and hold or until the correct time appears in the display.  
 Advances time, reverses time.

### To Set the Minute Timer

1. Push *timer*, "0:00" will appear in the display window. The timer can be set for any amount of time from 00:01 minute to 12:00 hours.
2. Push and hold until the correct amount of time appears in the display.  
 Advances time, reverses time. The minute timer will automatically start when the button is released. The ":" will flash to indicate Minute Timer mode.
3. When the set time has passed, the control will display "0:00" and beep three times. The timer will continue to beep until *clock* is pressed.
4. Push *clock* to cancel the timer and return to the clock mode.

## Flame Size

Never extend the flame beyond the outer edge of the utensil. A higher flame simply wastes heat and energy, and increases your risk of being burned by the flame.

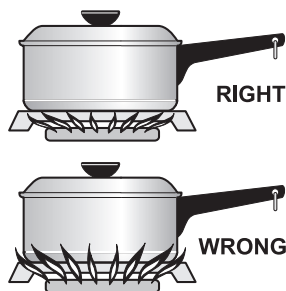

**For most cooking**, start on the highest control setting and then turn to a lower one to complete the process. Use the chart below as a guide for determining proper flame size for various types of cooking. The size and type of utensil used and the amount of food being cooked will influence the setting needed for cooking.

**For deep fat frying**, use a thermometer and adjust the surface control knob accordingly. If the fat is too cool, the food will absorb the fat and be greasy. If the fat is too hot, the food will brown so quickly that the center will be undercooked. Do not attempt to deep fat fry too much food at once as the food will neither brown nor cook properly.

*Flame Size	Type of Cooking
High Flame	Start most foods; bring water to a boil; pan broiling
Medium Flame	Maintain a slow boil; thicken sauces, gravies; steam
Low Flame	Keep foods cooking; poach; stew

\*These settings are based on using medium-weight aluminum pans with lids. Settings may vary when using other types of pans.

## Proper Burner Adjustments

The color of the flame is the key to proper burner adjustment. A good flame is clear, blue and hardly visible in a well-lighted room. Each cone of flame should be steady and sharply defined. Adjust or clean burner if flame is yellow-orange. To clean burner, see instructions under **General Cleaning**.

## Setting Surface Controls

The controls shown below may not look identical to the Surface Controls knobs on your range; They are only representational.

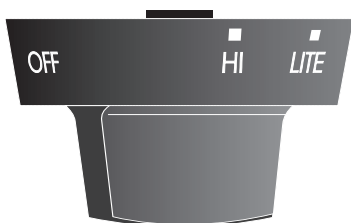
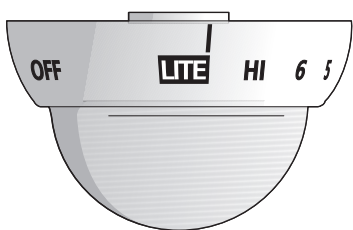

Your range is equipped with 4 standard burners, 2 standard and 2 large burners, or 3 standard and 1 large burner. Regardless of size, always select a burner and flame size appropriate to the pan. Never allow flames to extend beyond the outer edge of the pan.

For models equipped with the large burners, the larger burner is best used when bringing large quantities of liquid to temperature and when preparing larger quantities of food.

Each burner lights automatically from an electric ignitor each time a control knob is turned to the **LITE** position.

### To operate the surface burner:

1. Place cooking utensil on burner.
2. **Push** the Surface Control knob **in** and **turn counterclockwise** out of the **OFF** position.
3. Release the knob and rotate to the **LITE** position. **Note:** All four electronic ignitors will click at the same time. However, only the burner you are turning on will ignite.
3. Visually check that the burner has lit.
4. **Push** the control knob **in** and **turn counterclockwise** to the desired flame size. The control knobs do not have to be set at a particular mark. Use the guides and adjust the flame as needed. **DO NOT** cook with the Surface Control knob in the **LITE** position. (The electronic ignitor will continue to click if left in the **LITE** position.)

In the event of an electrical power outage, the surface burners can be lit manually. To light a surface burner, hold a lit match to the burner head, then push in and slowly turn the Surface Control knob to **LITE**. Use caution when lighting surface burners manually.

**CAUTION** Do not place plastic items such as salt and pepper shakers, spoon holders or plastic wrappings on top of the range when it is in use. These items could melt or ignite. Potholders, towels or wood spoons could catch fire if placed too close to a flame.

## Before Setting Oven Controls

## Arranging Oven Racks

(Some models may have one rack.) *ALWAYS ARRANGE OVEN RACKS WHEN THE OVEN IS COOL (PRIOR TO OPERATING THE OVEN).* Always use oven mitts when using the oven.

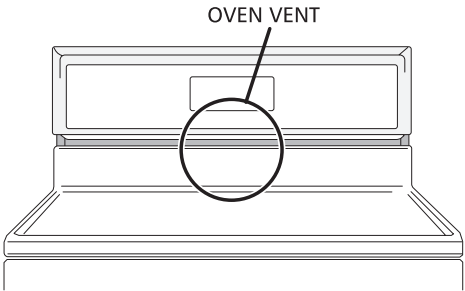
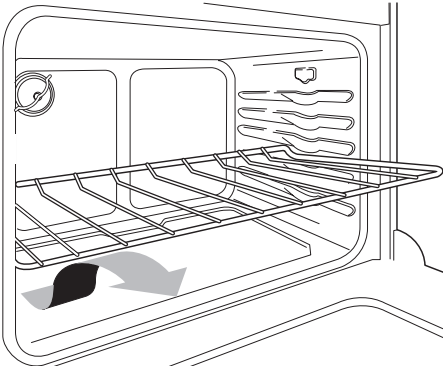
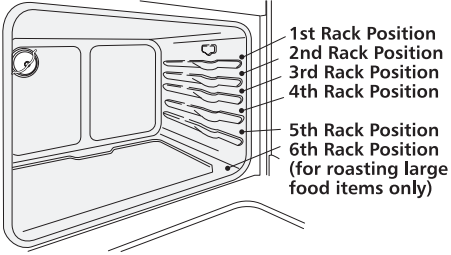
<p><b>Oven Vent Location</b> The oven vent is located <b>below the backguard</b>. When the oven is on, warm air is released through the vents. This venting is necessary for proper air circulation in the oven and good baking results.</p>	<p><b>REMOVING &amp; REPLACING OVEN RACKS</b> <b>To remove</b>, pull the rack forward until it stops. Lift up front of rack and slide out. <b>To replace</b>, fit the rack onto the guides on the oven walls. Tilt the front of the rack upward and slide the rack back into place.</p>	<p><b>ARRANGING OVEN RACKS WITH 5 RACK POSITIONS</b> <b>To bake on 1 rack</b>, place the rack on position 3 or 4. <b>To bake on 2 racks</b>, place the racks on positions 2 and 4.</p>
		

## Setting Oven Controls

The surface controls shown below may not look identical to the surface controls on your range. They are only representational.

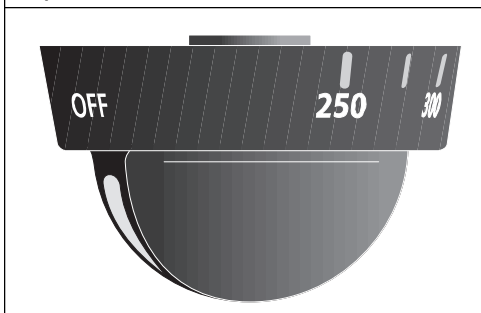

**FIGURE 1**

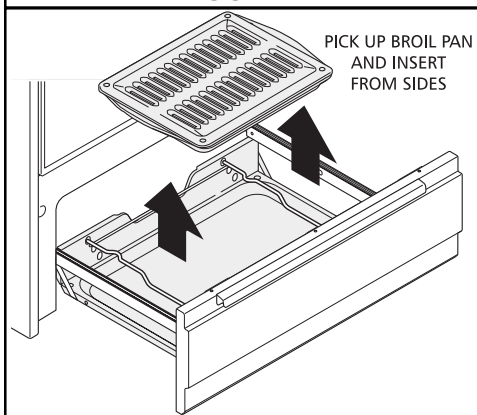

**FIGURE 2**

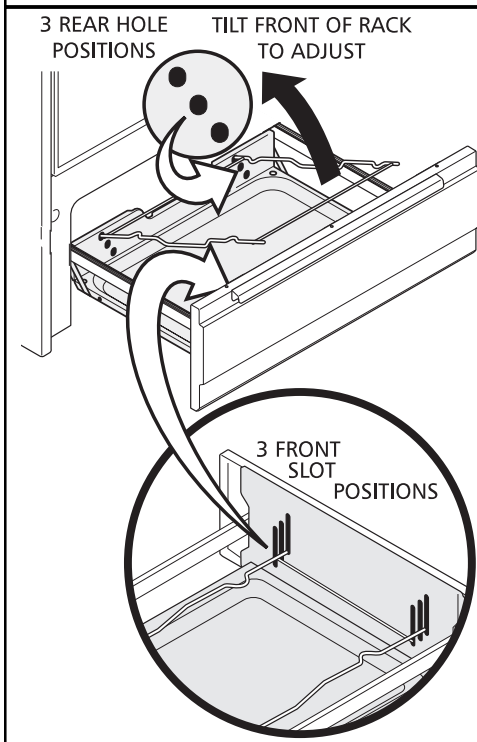

## Bake

1. Arrange oven racks while the oven is still cool. See "Arranging Oven Racks" under **Before Setting Oven Controls**.
2. Push in and turn the Temperature Control knob to the desired temperature.
3. Preheat the oven for 10 to 12 minutes before baking. Preheating is not necessary when roasting, cooking casseroles or broiling most foods.
4. When cooking is finished, turn the Temperature Control knob to OFF.

## Broil

1. Slide broiler drawer out to the stop position.
2. Remove broiler pan and insert, Figure 1.
3. Always position rack before setting control, while range is cool.
4. Position rack by tilting front of rack up and pulling rack out from locating holes in rear of broiler drawer. Reposition back of rack in the desired locating holes and allow front of rack to slide down into the corresponding slots in front of broiler drawer, Figure 2.

For rare meats, position the rack closer to the burner (upper position). For medium foods use middle position. For well-done foods such as chicken, lobster tails or thick cuts of meat, position the rack further from the burner (lower position).

5. Place insert on broiler pan, then place meat on insert. **DO NOT** use the broiler pan without the insert. **DO NOT** cover the insert with aluminum foil. The exposed fat could ignite.
6. Place broiler pan on rack; make sure the broiler pan and insert is positioned as shown, Figure 1.
7. Slide the broiler drawer all the way into the range.
8. Push in and turn the Temperature Control knob to BROIL.
9. Broil on one side until food is browned; turn and cook on the second side. Season and serve. **ALWAYS** pull the broiler drawer out to the stop position before turning or removing food.
10. When broiling is finished, turn the Temperature Control knob to OFF.
11. When removing broiler pan from broiler drawer always use pot holders.

**⚠ WARNING** **DO NOT** use the broiler drawer for storage. Items placed in the broiler drawer will catch fire.

**⚠ CAUTION** Should a broil fire occur, leave the broiler drawer closed and turn the oven off. If the fire continues, throw baking soda on the fire or use a fire extinguisher. **DO NOT** put water or flour on the fire. Flour may be explosive.

## Oven Cleaning

### Follow these cleaning precautions:

- Allow the oven to cool before cleaning.
- Wear rubber gloves when cleaning the appliance manually.

**REMOVE SPILLOVERS AND HEAVY SOILING AS SOON AS POSSIBLE. REGULAR CLEANINGS WILL REDUCE THE NUMBER OF MAJOR CLEANINGS LATER.**

**CAUTION** Ammonia must be rinsed before operating the oven. Provide adequate ventilation.

**CAUTION** DO NOT line the oven walls, bottom, racks or any other part of the appliance with aluminum foil. Doing so will destroy heat distribution, produce poor baking results and cause permanent damage to the oven interior (aluminum foil will melt to the interior surface of the oven).

## Porcelain Enamel Oven and Broiler Drawer

Porcelain has a smooth finish and is a type of glass fused to metal. Oven cleaners can be used on all interior oven surfaces.

### General Cleaning

Remove soils using hot, soapy water. Do not allow food spills with a high sugar or acid content (such as milk, tomatoes, sauerkraut, fruit juices or pie filling) to remain on the surface as they may cause a dull spot even after cleaning.

### To Remove Heavy Soil

1. Allow a dish of ammonia to sit in the oven overnight or for several hours with the oven door closed. Clean softened spots using hot, soapy water. Rinse well with water and a clean cloth.
2. If soil remains, use a soap-filled scouring pad or a nonabrasive cleaner. If necessary, use an oven cleaner following manufacturer's instructions. **DO NOT** mix ammonia with other cleaners.
3. Clean any soil from the oven frame, the door liner outside the oven door gasket and the small area at the front center of the oven bottom. Clean with hot, soapy water. Rinse well using clean water and a cloth.

### Adhere to the following precautions when using oven cleaners:

1. **DO NOT** spray on the electrical controls or switches because it could cause a short circuit and result in sparking or fire.
2. **DO NOT** allow a film from the cleaner to build up on the temperature sensing bulb; it could cause the oven to heat improperly. (The bulb is located in the rear of the oven.) Carefully wipe the bulb clean after each oven cleaning, being careful not to move the bulb. A change in its position could affect how the oven bakes. Avoid bending the bulb and capillary tube.
3. **DO NOT** spray any cleaner on the oven door trim or gasket, broiler drawer glides, handles or any exterior surfaces of the range, plastic or painted surfaces. The cleaner can damage these surfaces.

### To Clean the Oven Bottom

The oven bottom in porcelain enamel oven models can be removed for cleaning. See "To Remove and Replace Oven Bottom" under **General Cleaning**.

Clean using hot, soapy water, a mild abrasive cleanser, a soap-filled abrasive pad or oven cleaner following manufacturer's instructions.

## Oven Cleaning

(continued)

### Adhere to the following cleaning precautions:

- Allow the oven to cool before cleaning.
- Wear rubber gloves when cleaning the appliance manually.

REMOVE SPILLOVERS AND HEAVY SOILING AS SOON AS POSSIBLE. REGULAR CLEANINGS WILL REDUCE THE NUMBER OF MAJOR CLEANINGS LATER.

**CAUTION** Ammonia must be rinsed before operating the oven. Provide adequate ventilation.

**WARNING** DO NOT use oven cleaners, gritty cleansers, coarse abrasive pads or brushes, silicone sprays or metal scrapers on the interior walls, oven frame or ceiling of a continuous cleaning oven. **Permanent damage to the oven may result.**

**CAUTION** DO NOT line the oven walls, bottom, racks or any other part of the appliance with aluminum foil. Doing so will destroy heat distribution, produce poor baking results and cause permanent damage to the oven interior (aluminum foil will melt to the interior surface of the oven).

## Continuous Cleaning Oven (some models)

Continuous cleaning ovens have a special coating which is a porous ceramic material. This rough coating tends to prevent grease spatters from forming little beads which run down the side walls leaving streaks that require hand cleaning. Instead, when spatter hits the porous coating, it disperses and is partially absorbed. This spreading action increases the exposure of oven soil to heated air, making it less noticeable.

*Soil may not disappear completely.* Remaining soil will gradually fade with continued oven use. *The special coating works best on small amounts of spatter.* Larger spills, or spills generating from sugar, egg and dairy mixtures, do not clean as well.

### If difficult soils occur:

1. Remove the oven racks and cookware.
2. Remove soils by completing steps **a** or **b** below:
  - a) Use hot, soapy water and wash soils using a nylon-bristly brush or a nylon mesh scouring pad. **DO NOT** rub or scrub with paper towels, cloths or sponges. They will leave lint on the oven coating.
  - b) Apply ammonia with a sponge and dab it into the porous coating. Leave the ammonia on the soiled area for 30 minutes.
3. Rinse with clear water.
4. Close the oven door and push in and turn the Temperature Control knob to 450°F (230°C).
5. Operate oven for 15 minutes.
6. Remaining soil will fade with continued oven use.

### To Clean the Oven Bottom

**The oven bottom is not a continuous cleaning finish. Oven cleaners can be used on the oven bottom only.** Remove the oven bottom before using oven cleaners. **DO NOT** get oven cleaner on any of the continuous cleaning surfaces.

**Note:** To remove or replace oven bottom, see "To Remove and Replace Oven Bottom" under **General Cleaning**.

*To clean,* use hot, soapy water, a mild abrasive cleanser, a soap-filled abrasive pad or oven cleaner (**on the oven bottom only**) following manufacturer's instructions.

## General Cleaning

(continued)

Unlike the standard gas range, THIS COOKTOP IS NOT REMOVABLE. Do not attempt to remove or lift the cooktop.

**Note:** The burner cap assembly refers to all parts of the sealed burner unit (burner cap, burner pan (some models), trim ring (some models), locating tab, burner base and electrode).

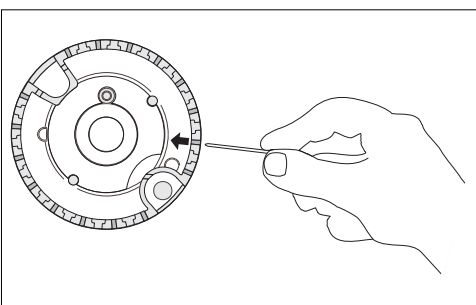
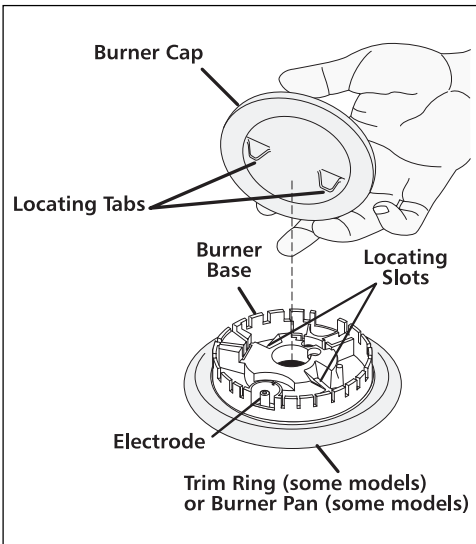

**CAUTION** Use caution when replacing the burner cap so the electrode is not damaged. This may cause a delayed ignition or prevent the burner from igniting.

**CAUTION** Any additions, changes or conversions required in order for this appliance to satisfactorily meet the application needs must be made by an authorized Frigidaire Home Products Distributor or Qualified Agency.

### To Clean the Cooktop

The cooktop is designed to make cleaning easier. Because the four burners are sealed, cleanups are easy when spillovers are cleaned up immediately.

To clean, wipe with a clean, damp cloth and wipe dry.

### To Clean the Contoured Well Areas, Burner Cap Assembly, Trim Ring (some models), Burner Pan (some models) and Burner Base

The contoured well areas, burner cap assembly, trim ring (some models), burner pan (some models) and burner base should be routinely cleaned. Keeping the burner ports clean will prevent improper ignition and an uneven flame. See instructions below.

#### To Clean the Contoured Well Areas

The contoured well is a recessed area located around each burner unit. If a spill occurs in one of the four well areas, blot up spill with an absorbent cloth. Rinse with a clean, damp cloth and wipe dry.

#### To Remove the Burner Cap Assembly

The burner cap assembly parts differ per model. Your assembly will consist of one of the following combinations: burner cap and trim ring; burner cap and burner pan; or burner cap, trim ring and burner pan. Remove in the following order: (1st) burner cap, (2nd) trim ring and (3rd) burner pan. **Do not operate the burners without the burner cap assembly in place.**

#### To Clean the Burner Cap, Burner Pan (some models) and Trim Ring (some models)

Use a soap-filled scouring pad or a mild abrasive cleanser to clean burner caps, trim rings and burner pans.

#### To Clean the Burner Base and Gas Opening

The ports (or slots) around the burner base must be routinely cleaned. Use a small-gauge wire or needle to clean small slots or holes. Use care to prevent damage to the electrode. If a cleaning cloth should catch the electrode, it could break or damage the electrode. If the electrode is damaged or broken, the surface burner will not light.

For proper flow of gas and ignition of the burner—DO NOT ALLOW SPILLS, FOOD, CLEANING AGENTS OR ANY OTHER MATERIAL TO ENTER THE GAS OPENING. Gas must flow freely through the small hole in the brass orifice for the burners to light properly. If the orifice gas opening becomes soiled or clogged, use a small-gauge wire or needle to clean. ALWAYS keep the burner cap assembly in place whenever a surface burner is in use.

#### To Replace the Burner Cap Assembly



Make sure the burner cap assembly is thoroughly dry before placing back on the burner.

1. Lower burner pan (some models) into place around the burner base.
2. Replace trim ring (some models).
3. Find the locating tabs on the burner cap and place in the locating slots in the burner base. Make sure each burner cap is properly aligned and level.
4. Turn the burner on to determine if it will light. If the burner does not light after cleaning, contact an authorized servicer. Do not service the sealed burner yourself.

## General Cleaning

### Cleaning Various Parts of Your Range

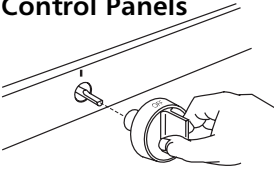
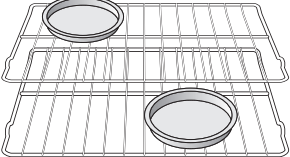
Before cleaning any part of the range, be sure all controls are turned OFF and the range is cool. Remove spillovers and heavy soiling as soon as possible. Regular cleanings will reduce the effort required for major cleanings later.

Surfaces	How to Clean
Aluminum (Trim Pieces) & Vinyl	Use hot, soapy water and a cloth. Dry with a clean cloth.
Glass, Painted and Plastic Body Parts, Control Knobs and Decorative Trim Pieces	<i>For general cleaning</i> , use hot, soapy water and a cloth. <i>For more difficult soils and built-up grease</i> , apply a liquid detergent directly onto the soil. Leave on soil for 30 to 60 minutes. Rinse with a damp cloth and dry. <b>DO NOT</b> use abrasive cleaners on any of these materials; they can scratch.
<b>Control Panels</b> 	<i>Before cleaning the control panel</i> , turn all controls to OFF and remove the control knobs. To remove, pull each knob straight off the shaft. Clean as instructed above. Squeeze excess water from the cloth before wiping the panel; especially when wiping around the controls. Excess water in or around the controls may cause damage to the appliance. To replace knobs after cleaning, line up the flat sides of both the knob and the shaft, then push the knob(s) into place.
<b>Porcelain Enamel Burner Grates, Cooktop Surface, Below Cooktop, Broiler Pan &amp; Insert, Broiler Drawer, Door Liner and Oven Bottom</b>	Clean burner grates, broiler pan and insert in the dishwasher and dry upon removal. If soils are not removed, follow the cooktop cleaning instructions below.  Gentle scouring with a soapy scouring pad will remove most spots. Rinse with a 1:1 solution of clean water and ammonia. <i>If necessary</i> , cover difficult spots with an ammonia-soaked paper towel for 30 to 40 minutes. Rinse with clean water and a damp cloth, then scrub with a soap-filled scouring pad. Rinse and wipe dry with a clean cloth. Remove all cleaners or the porcelain may become damaged during future heating. <b>DO NOT</b> use spray oven cleaners on the range top.
<b>Stainless Steel, Chrome Parts, Drip Pans</b>	Clean with hot, soapy water and a dishcloth. Rinse with clean water and a cloth. Cover stubborn spots with an ammonia-soaked paper towel for 30-40 minutes. Rinse. Cleaners made especially for stainless steel are recommended. Be sure to rinse the cleaners as bluish stains may occur during heating and cannot be removed.
<b>Oven Racks</b> 	Remove racks. See "Removing and Replacing Oven Racks" under <b>Before Setting Oven Controls</b> . Use a mild, abrasive cleaner, following manufacturer's instructions. Rinse with clean water and dry. After cleaning the racks, rub the sides of the racks with wax paper or a cloth containing a small amount of baby oil or salad oil (this will make the racks glide easier into the rack positions).  The holes in the burners of your range must be kept clean at all times for proper ignition and a complete, even flame. Clean the burner holes routinely with a small gauge wire or needle and especially after bad spillovers which could clog these holes.
<b>Surface Burners - Sealed Burner Units - Burner Cap, Trim Ring (some models), Burner Pans (some models), and Burner Base</b>	The holes in the burners of your range must be kept clean at all times for proper ignition and a complete, even flame. Clean the burner holes routinely with a small gauge wire or needle and especially after bad spillovers which could clog these holes.  To remove, clean and replace sealed burner units, follow the instructions under <b>General Cleaning</b> . <b>DO NOT</b> put burner units in the dishwasher.
<b>Oven Door</b> 	To clean oven door, wash with hot, soapy water and a clean cloth. <b>DO NOT</b> immerse the door in water.  <b>DO NOT</b> clean the oven door gasket. The oven door gasket is made of a silicone rubber material which is essential for a good seal. Care should be taken not to rub, damage or remove the gasket.

## General Cleaning

(continued)

**CAUTION** The door is heavy. For safe, temporary storage, lay the door flat with the inside of the door facing down.

### To Remove and Replace Oven Door

#### To Remove Oven Door:

1. Open the door.
2. Remove screws located on the inside of the oven door near the hinges **A** (one on each side.)
3. Close the door to the quarter-open position. Grasp the door firmly on both sides and lift up and off the hinges.
4. To clean oven door, follow the instructions provided in the cleaning chart under **General Cleaning**

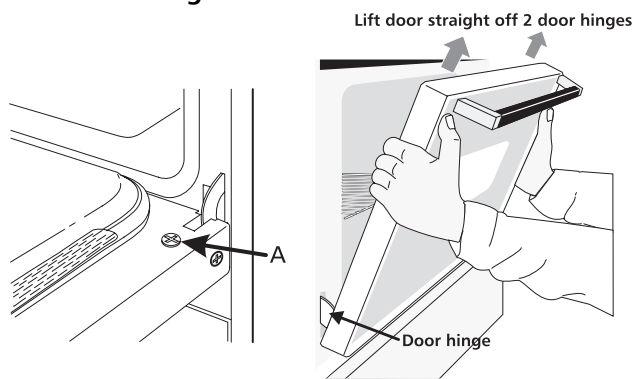

#### To Replace Oven Door:

1. Be sure the hinge arms are in the quarter-open position. Be careful if pulling the hinges open by hand. The hinges may snap back against the oven frame and could pinch fingers.
2. Hold the door at the sides near the top. Insert the hinge arms into slots at the bottom of the door.
3. Hinge arms must go into the range slots evenly. The hinge arms should be inserted into the bottom corners of the door as far as they can go.
4. If the door is not in line with the oven frame, remove it and repeat the above steps.

### To Remove and Replace Oven Bottom

#### To Remove Oven Bottom:

1. Remove the oven racks.
2. Remove the two hold-down screws (Figure 1) at the rear of the oven bottom panel. If the screws are too tight to remove by hand, use a screwdriver.
3. To lift out the bottom panel, place fingers in the slots in the bottom. Lift the rear of the panel up and back until it is clear of the lip at the front of the panel (Figure 2).
4. Lift the bottom up and out.

#### To Replace the Oven Bottom:

1. Place the oven bottom in the oven with the back raised about 6" or until you can insert the front of the oven bottom under the hold-down lip at the front of the panel.
2. Push the back of the oven bottom down fully into place on the metal flanges and insert the hold-down screws.

### To Change the Oven Light (some models)

1. Turn electrical power off at the main source or unplug the range.
2. Replace bulb with a new 40 watt appliance bulb.
3. Turn power back on again at the main source (or plug the range back in).
4. The clock (if equipped) will then need to be reset. To reset, see **Setting the Clock and Minute Timer** in this Owner's Guide.

**CAUTION** Be sure the range is unplugged and all parts are COOL before replacing the surface or oven lights. Wear a leather-faced glove for protection against possible broken glass.

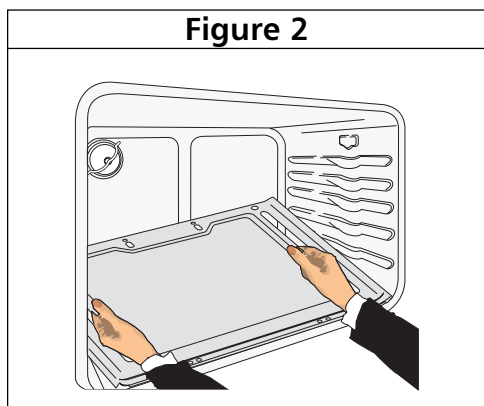
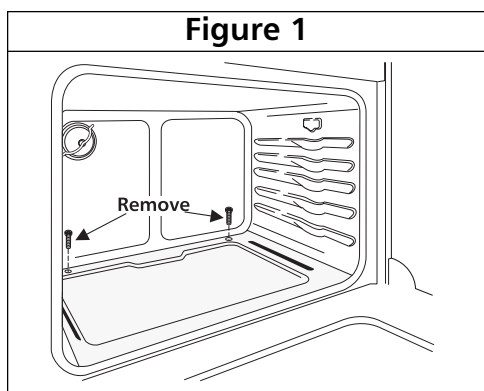

## Changing Oven Light

(some models)

---

## Avoid Service Checklist

Before you call for service, review this list. It may save you time and expense. The list includes common occurrences that are not the result of defective workmanship or materials in this appliance.

### OCCURRENCE

### POSSIBLE CAUSE/SOLUTION

Range is not level.

Poor installation. Place oven rack in center of oven. Place a level on the oven rack. Adjust leveling legs at base of range until the rack is level. When range is level, cooktop may appear out of alignment if countertop is not level.

Weak, unstable floor. Be sure floor is level and can adequately support range. Contact a carpenter to correct sagging or sloping floor.

Kitchen cabinet misalignment may make range appear to be unlevel. Be sure cabinets are square and have sufficient room for range clearance.

Cannot move appliance easily. Appliance must be accessible for service.

Cabinets not square or are built in too tight. Contact a cabinet maker to correct the problem.

Contact builder or installer to make appliance accessible.

Carpeting interferes with range. Provide sufficient space so range can be lifted over carpet.

Gas line is hard-plumbed. Have a flexible A.G.A./C.G.A. approved metal appliance connector installed.

Surface burners do not light.

Surface Control knob has not been completely turned to LITE. Push in and turn the Surface Control knob to LITE until burner ignites and then turn control knob to desired flame size.

Burner ports are clogged. Clean burners. See "To Clean the Contoured Well Areas, Burner Cap Assembly, Trim Ring (some models), Burner Pan (some models) and Burner Base" under **General Cleaning**. With the burner off, clean ports with a small-gauge wire or needle.

Range power cord is disconnected from outlet (Electric Ignition Models only). Be sure cord is securely plugged into the outlet.

Electrical power outage (electric ignition models only). Burners can be lit manually. See **Setting Surface Controls** in this Owner's Guide.

Surface burner flame burns half way around.

Burner ports are clogged. With the burner off, clean ports by using a small-gauge wire or needle.

Moisture is present after cleaning. Lightly fan the flame and allow burner to operate until flame is full. Dry the burners thoroughly following instructions in the **General Cleaning** section.

Surface burner flame is orange.

Dust particles in main line. Allow the burner to operate a few minutes until flame turns blue.

In coastal areas, a slightly orange flame is unavoidable due to salt air.

Oven does not operate.

Be sure the electronic oven controls are set correctly for the desired function. See **Setting Oven Controls** in this Owner's Guide or **Entire Appliance Does Not Operate** (see below).

Be sure regulator gas valve is "ON". See installation instructions.

<b>Entire appliance does not operate.</b>	<p>Make sure electrical cord/plug is plugged tightly into outlet (electric ignition models only).</p> <hr/> <p>Service wiring not complete. Contact servicer or dealer.</p> <hr/> <p>Electrical power outage (electric ignition models only). Check house lights to be sure. Call your local electric company for service. Surface burners can be lit manually. See <b>Setting Surface Controls</b> in this Owner's Guide.</p> <hr/> <p>Be sure gas supply is turned on.</p>
<b>Cooktop and/or oven light (some models) does not work.</b>	<p>Burned-out or loose bulb. See <b>Changing Cooktop and/or Oven Lights (some models)</b> section in this Owner's Guide to replace or tighten the bulb.</p>
<b>Oven smokes excessively during broiling.</b>	<p>Meat too close to the broil burner. Reposition the rack to provide more clearance between the meat and the broiler.</p> <hr/> <p>Meat not properly prepared. Remove excess fat from meat. Slash remaining fatty edges to prevent curling, but do not cut into the lean.</p> <hr/> <p>Broiler pan used without grid or grid covered with foil. <b>DO NOT</b> use the broiler pan without the grid or cover the grid with foil.</p> <hr/> <p>Broiler drawer needs to be cleaned. Excessive smoking is caused by a build up of grease or food spatters. If the broiler is used often, clean on a regular basis.</p> <hr/> <p>Broiler drawer is open. Drawer/door should be closed when broiling.</p>
<b>Poor baking results.</b>	<p>Many factors affect baking results. Make sure the proper rack position is used. Center food in the oven and space pans to allow air to circulate. Allow the oven to preheat to the set temperature before placing food in the oven. Try adjusting the recipe's recommended temperature or baking time.</p>

# TAPPAN RANGE WARRANTY

Your Tappan product is protected by this warranty

	WARRANTY PERIOD	TAPPAN, THROUGH ITS AUTHORIZED SERVICERS, WILL:	THE CONSUMER WILL BE RESPONSIBLE FOR:
<b>FULL ONE-YEAR WARRANTY</b>	One year from original purchase date.	Pay all costs for repairing or replacing any parts of this appliance which prove to be defective in materials or workmanship.	Costs of service calls that are listed under <b>NORMAL RESPONSIBILITIES OF THE CONSUMER.*</b>
<b>LIMITED WARRANTY (Applicable to the State of Alaska)</b>	Time period listed above.	All of the provisions of the full warranty above and the exclusions listed below apply.	Costs of the technician's travel to the home and any costs for pick up and delivery of the appliance required because of service.

Your appliance is warranted by Frigidaire Company, a division of White Consolidated Industries, Inc. We authorize no person to change or add to any of our obligations under this warranty. Our obligations for service and parts under this warranty must be performed by Frigidaire Company Consumer Services or an authorized Tappan servicer.

**\*NORMAL RESPONSIBILITIES OF THE CONSUMER**

**This warranty applies only to products in ordinary household use, and the consumer is responsible for the items listed below:**

1. Proper use of the appliance in accordance with instructions provided with the product.
2. Proper installation by an authorized servicer in accordance with instructions provided with the appliance and in accordance with all local plumbing, electrical and/or gas codes.
3. Proper connection to a grounded power supply of sufficient voltage, replacement of blown fuses, repair of loose connections or defects in house wiring.
4. Expenses for making the appliance accessible for servicing, such as removal of trim, cupboards, shelves, etc., which are not a part of the appliance when it was shipped from the factory.
5. Damages to finish after installation.
6. Replacement of light bulbs and/or fluorescent tubes (on models with these features).

**EXCLUSIONS**

**This warranty does not cover the following:**

1. CONSEQUENTIAL OR INCIDENTAL DAMAGES SUCH AS PROPERTY DAMAGE AND INCIDENTAL EXPENSES RESULTING FROM ANY BREACH OF THIS WRITTEN OR ANY IMPLIED WARRANTY.  
*Note: Some states do not allow the exclusion or limitation of incidental or consequential damages, so this limitation or exclusion may not apply to you.*
2. Service calls which do not involve malfunction or defects in workmanship or material, or for appliances not in ordinary household use. The consumer shall pay for such service calls.
3. Damages caused by services performed by persons other than authorized Tappan servicers; use of parts other than Frigidaire Company Genuine Renewal Parts; obtained from persons other than such servicers; or external causes such as abuse, misuse, inadequate power supply or acts of God.
4. Products with original serial numbers that have been removed or altered and cannot be readily determined.

**IF YOU NEED SERVICE**

Keep your bill of sale, delivery slip, or some other appropriate payment record. The date on the bill establishes the warranty period should service be required. If service is performed, it is in your best interest to obtain and keep all receipts. This written warranty gives you specific legal rights. You may also have other rights that vary from state to state. Service under this warranty must be obtained by following these steps, in order:

1. Contact Frigidaire Company Consumer Services or an authorized Tappan servicer.
2. If there is a question as to where to obtain service, call or write our Consumer Relations Department at:

Frigidaire Home Products Consumer Relations  
P.O. Box 212378  
Augusta, Georgia 30917-2378  
(800) 944-9044



Product features or specifications as described or illustrated are subject to change without notice. All warranties are made by White Consolidated Industries, Inc. This warranty applies only in the 50 states of the U.S.A. and Puerto Rico.